

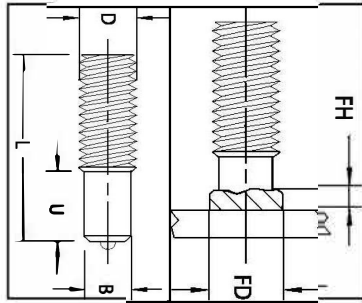

TRU-FIT PRODUCTS • TRU-WELD

QUALITY WELD STUDS, STUD WELDING EQUIPMENT AND FASTENERS SINCE 1928

Atlanta • Calgary • Chicago • Dallas • Denver • Houston • Kansas City • Las Vegas • Medina • New York City • Salt Lake City • Smithville • Toronto • Vancouver



PARTIAL THREAD STUD

TYPE T P STUD

TYPE P FERRULE SUPPLIED

D Stud Diameter	L Length (BW)	TRU-WELD Part Number	B Base Diameter	U Base Length	FD Weld Fillet Diameter	FH Weld Fillet Height	Ferrule Part Number
1/4-20	3/4	TP04-012-12	.215	3/8	5/16	3/32	FER04-P
5/16-18	3/4	TP05-012-12	.275	3/8	13/32	7/64	FER05-P
3/8-16	3/4	TP06-012-12	.330	13/32	7/16	7/64	FER06-P
7/16-14	7/8	TP07-014-12	.87	7/16	1/2	1/8	FER07-P
1/2-13	7/8	TP08-014-12	.448	1/2	19/32	5/32	FER08-P
5/8-11	1	TP10-016-12	.562	5/8	3/4	3/16	FER10-P
3/4-10	1-3/16	TP12-019-12	.680	13/16	7/8	1/4	FER12-P
7/8-9	1-11/16	TP14-027-12	.798	7/8	1	5/16	FER14-P
1-8	1-11/16	TP16-027-12	.915	15/16	1-1/8	5/16	FER16-P

TP STUDS are used in all types of applications.

Length: TRU-WELD TP Studs can be made in any length above the standard minimum.

Material: Low Carbon Steel, ASTM A29 / A108, 1010-1020. TP Studs are also available in weldable stainless steel.

Mechanical Property Requirements	
Tensile Strength	61,000 psi min.
Yield Strength	49,000 psi min.
Elongation (% in 2 in.)	17% min.
Elongation (% in 5x dia.)	14% min.
Reduction of Area	50% min.

DIAMETER	CHUCK PART #	Light Duty Standard		Light Duty Split		Standard Combination
		FOOT PART #	GRIP PART #	FOOT PART #	GRIP PART #	FOOT AND GRIP #
1/4	CN-025	B-1N	GN-025	B-1C	GC-025	QN-025
5/16	CN-031	B-1N	GN-031	B-1C	GC-031	QN-031
3/8	CN-037	B-1N	GN-050	B-1C	GC-050	QN-050
7/16	CN-043	B-1N	GN-043	B-1C	GC-043	QN-044
1/2	CN-050	B-1N	GN-050	B-1C	GC-050	QN-050
5/8	CN-062	B-2N	GN-062	B-2C	GC-062	QN-062
3/4	CN-075	B-2N	GN-075	B-2C	GC-075	QN-075
7/8	CN-087	B-3N	GN-087	B-3C	GC-087	QN-087
1	CN-100	B-3N	GN-100	B-3C	GC-100	QN-100